



SP-3001

Scope Mount Ø30 H30mm/1.18" 0MIL PIC

Picatinny mount for use on bolt action rifles

Rings: 30 mm
Tilt: 0 MIL/MOA
Height: 30 mm/1.18"
Length: 126 mm/4.96"
Weight: 237 g/8.4 oz
Interfaces: 7 sets
EAN: 7340150700065



The **IDEAL SCOPE MOUNT SYSTEM** series of mounts feature **seven set of interfaces** to **attach any of more than 40 different accessories**, and has a bubble level integrated in the rear plane of the mount body to prevent canting of the rifle. The rings are diagonally cut for increased visibility of the elevation and windage turrets (US Patent 8,733,011).

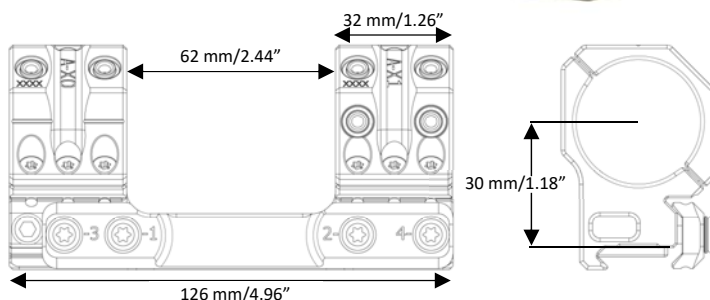

The mounts are machined from billet 7075 T651 aluminum and all aluminum parts are hardcoat anodized. The Torx 20 ring and clamping screws are zinc-nickel coated for corrosion resistance. The screws come pre-waxed from the factory to ensure proper torque values.

The mount is shipped with a manual and a "wedge" leveling key.

NOTE:

The SP-3001 is designed for use on rifles with MIL-STD-1913 or STANAG 4694 rails, and is especially suitable for bolt action rifles with 1-piece Picatinny rails. The SP-3001 will fit most 30 mm scope tubes except for scopes with extended erector housings, such as the US Optics TPAL/EREK.

CONTACT

Spuhr i Dalby AB

Phone: +46 46 712 012

Web: www.spuhr.com

Address: Terminalvägen 19
SE-246 42 Löddeköpinge
Sweden